

Conveyor Filter UNIFIL 250 with tank

SSR TRADE
High quality, low costs

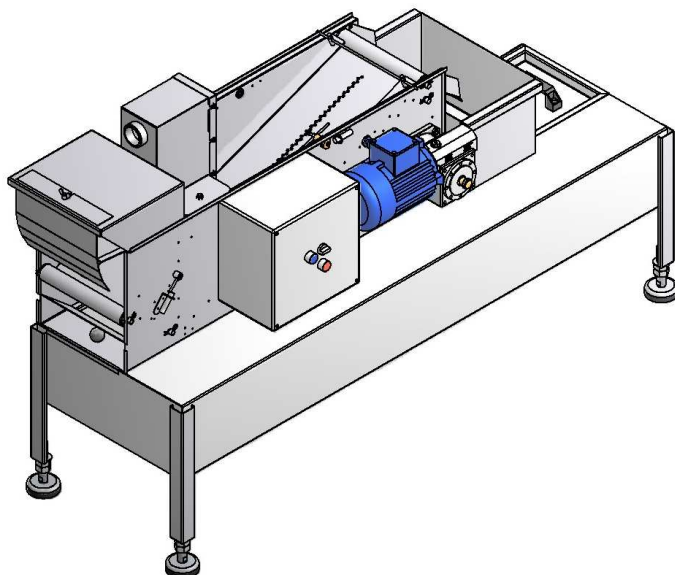
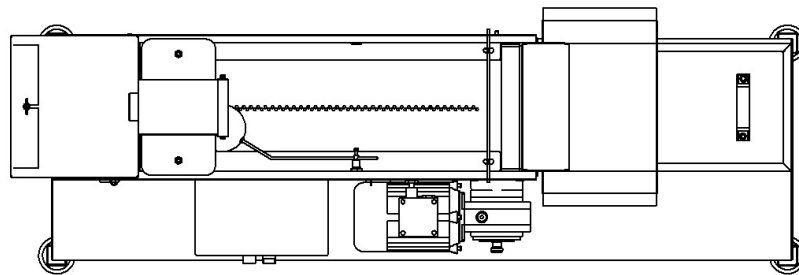
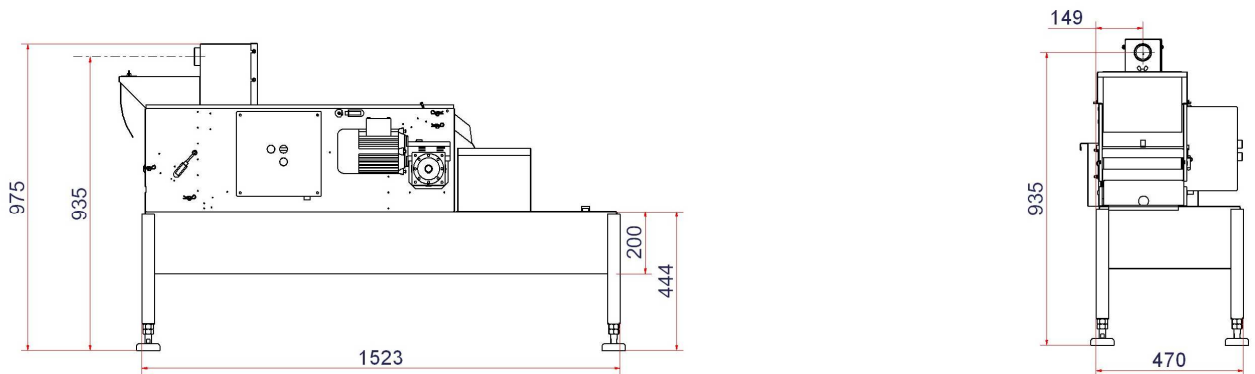

Power supply	3 x 400 VAC, 50 Hz		
Control voltage	24 VAC, 50 Hz		
Standard controls	3-point contact for automatic-0-manual operation Reset of gear motor Indicator for paper 24 Volt outlet		
Receptacle	Included		
Inlet types	Top inlet (standard) Side inlet		
Conveyor filter	Weight [kg]	Capacity [l/min]*	Capacity [l/min]**
UNIFIL 250 with tank		80	50
Tankvolume	135 litre brutto		

SSR TRADE
Sundparken 7
DK-3600 Frederikssund
Denmark
Tel. +45 29922965
Fax +45 47316610
www.ssr-trade.com
info@ssr-trade.com

* The capacity measurement was performed with a P60 filter cloth and a fluid with a viscosity of 1 cSt. At 20 °C.

** The capacity measurement was performed with a P60 filter cloth and a fluid with a viscosity of 12 cSt. At 20 °C.